



# Milan Series

## Quickstart Guide



**EN Important Safety Instructions**

Terminals marked with this symbol carry electrical current of sufficient magnitude to constitute risk of electric shock. Use only high-quality commercially-available speaker cables with plugs pre-installed. All other installation or modification should be performed only by qualified personnel.



This symbol, wherever it appears, alerts you to the presence of uninsulated dangerous voltage inside the enclosure - voltage that may be sufficient to constitute a risk of shock.



This symbol, wherever it appears, alerts you to important operating and maintenance instructions in the accompanying literature. Please read the manual.



**Caution**  
To reduce the risk of electric shock, do not remove the top cover (or the rear section). No user serviceable parts inside. Refer servicing to qualified personnel.



**Caution**  
To reduce the risk of fire or electric shock, do not expose this appliance to rain and moisture. The apparatus shall not be exposed to dripping or splashing liquids and no objects filled with liquids, such as vases, shall be placed on the apparatus.



**Caution**  
These service instructions are for use by qualified service personnel only. To reduce the risk of electric shock do not perform any servicing other than that contained in the operation instructions. Repairs have to be performed by qualified service personnel.

1. Read these instructions.
2. Keep these instructions.
3. Heed all warnings.
4. Follow all instructions.
5. Do not use this apparatus near water.

6. Clean only with dry cloth.
7. Do not block any ventilation openings. Install in accordance with the manufacturer's instructions.
8. Do not install near any heat sources such as radiators, heat registers, stoves, or other apparatus (including amplifiers) that produce heat.
9. Do not defeat the safety purpose of the polarized or grounding-type plug. A polarized plug has two blades with one wider than the other. A grounding-type plug has two blades and a third grounding prong. The wide blade or the third prong are provided for your safety. If the provided plug does not fit into your outlet, consult an electrician for replacement of the obsolete outlet.
10. Protect the power cord from being walked on or pinched particularly at plugs, convenience receptacles, and the point where they exit from the apparatus.
11. Use only attachments/accessories specified by the manufacturer.



12. Use only with the cart, stand, tripod, bracket, or table specified by the manufacturer, or sold with the apparatus.

When a cart is used, use caution when moving the cart/apparatus combination to avoid injury from tip-over.

13. Unplug this apparatus during lightning storms or when unused for long periods of time.
14. Refer all servicing to qualified service personnel. Servicing is required when the apparatus has been damaged in any way, such as power supply cord or plug is damaged, liquid has been spilled or objects have fallen into the apparatus, the apparatus has been exposed to rain or moisture, does not operate normally, or has been dropped.
15. The apparatus shall be connected to a MAINS socket outlet with a protective earthing connection.

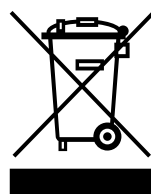

16. Where the MAINS plug or an appliance coupler is used as the disconnect device, the disconnect device shall remain readily operable.

**LEGAL DISCLAIMER**

TECHNICAL SPECIFICATIONS AND APPEARANCES ARE SUBJECT TO CHANGE WITHOUT NOTICE AND ACCURACY IS NOT GUARANTEED. BEHRINGER, KLARK TEKNIK, MIDAS, BUGERA, AND TURBOSOUND ARE PART OF THE MUSIC GROUP (MUSIC-GROUP.COM). ALL TRADEMARKS ARE THE PROPERTY OF THEIR RESPECTIVE OWNERS. MUSIC GROUP ACCEPTS NO LIABILITY FOR ANY LOSS WHICH MAY BE SUFFERED BY ANY PERSON WHO RELIES EITHER WHOLLY OR IN PART UPON ANY DESCRIPTION, PHOTOGRAPH OR STATEMENT CONTAINED HEREIN. COLORS AND SPECIFICATIONS MAY VARY FROM ACTUAL PRODUCT. MUSIC GROUP PRODUCTS ARE SOLD THROUGH AUTHORIZED FULLFILLERS AND RESELLERS ONLY. FULLFILLERS AND RESELLERS ARE NOT AGENTS OF MUSIC GROUP AND HAVE ABSOLUTELY NO AUTHORITY TO BIND MUSIC GROUP BY ANY EXPRESS OR IMPLIED UNDERTAKING OR REPRESENTATION. THIS MANUAL IS COPYRIGHTED. NO PART OF THIS MANUAL MAY BE REPRODUCED OR TRANSMITTED IN ANY FORM OR BY ANY MEANS, ELECTRONIC OR MECHANICAL, INCLUDING PHOTOCOPYING AND RECORDING OF ANY KIND, FOR ANY PURPOSE, WITHOUT THE EXPRESS WRITTEN PERMISSION OF MUSIC GROUP IP LTD.

ALL RIGHTS RESERVED.

© 2013 MUSIC Group IP Ltd.  
Trident Chambers, Wickhams Cay,  
P.O. Box 146, Road Town, Tortola,  
British Virgin Islands

**LIMITED WARRANTY**

For the applicable warranty terms and conditions and additional information regarding MUSIC Group's Limited Warranty, please see complete details online at [www.music-group.com/warranty](http://www.music-group.com/warranty).

## Introduction

Congratulations, you have purchased a professional loudspeaker product from the Milan series of loudspeakers, designed to give you the best in audio quality and many years of reliable, trouble-free operation. It offers excellent pattern control, superior audio quality, proven reliability, ease of setup, consistent performance, and the backing of a world leader in acoustics technology including a comprehensive warranty against manufacturing defects. Please read through this guide carefully before you attempt to operate the loudspeaker system. It contains valuable information which will enable you to quickly and easily connect the loudspeakers to your outboard equipment; and important system and set-up checks.

## Thanks

Thank you for choosing a TURBOSOUND loudspeaker product for your application.

By engaging in an on-going rigorous program of research and development all TURBOSOUND products are carefully engineered for world class performance and reliability.

If you would like further information about this or any other TURBOSOUND product, please contact us. Detailed product information is available on our website at: [turbosound.com](http://turbosound.com)

We look forward to helping you in the near future.

## Unpacking

After unpacking the unit please check carefully for damage. If damage is found, please notify the carrier concerned at once. You, the consignee, must instigate any claim. Please retain all packaging in case of future re-shipment.

## Models covered by this Quick Start Guide

Milan M10, Milan M12, Milan M15, Milan M15B, Milan M18B

## Connection Diagrams

### Small duo setup using the integrated mixer and Mix Out function

The integrated two channel mixer allows the simultaneous use of either two low impedance dynamic microphones, a microphone and a line level source, or two line level sources. The line level source(s) can be an acoustic instrument such as a guitar with either passive or active on-board electrics, a keyboard, or MP3 player. Connect dynamic microphones directly to either of the combo jack/XLR input connectors, switch the **MIC/LINE** switch to **MIC** and adjust the volume level as desired. Connect line sources to either of the combo jack/XLR connectors, switch the **MIC/LINE** switch to **LINE** and adjust the volume control as desired. Switch the **LOW CUT** filter to 'OFF' and switch the **PROG** switch to 'MUSIC'. Additional microphones and sources can be connected by using the **MIX OUT** function to daisy-chain to additional Milan loudspeakers.

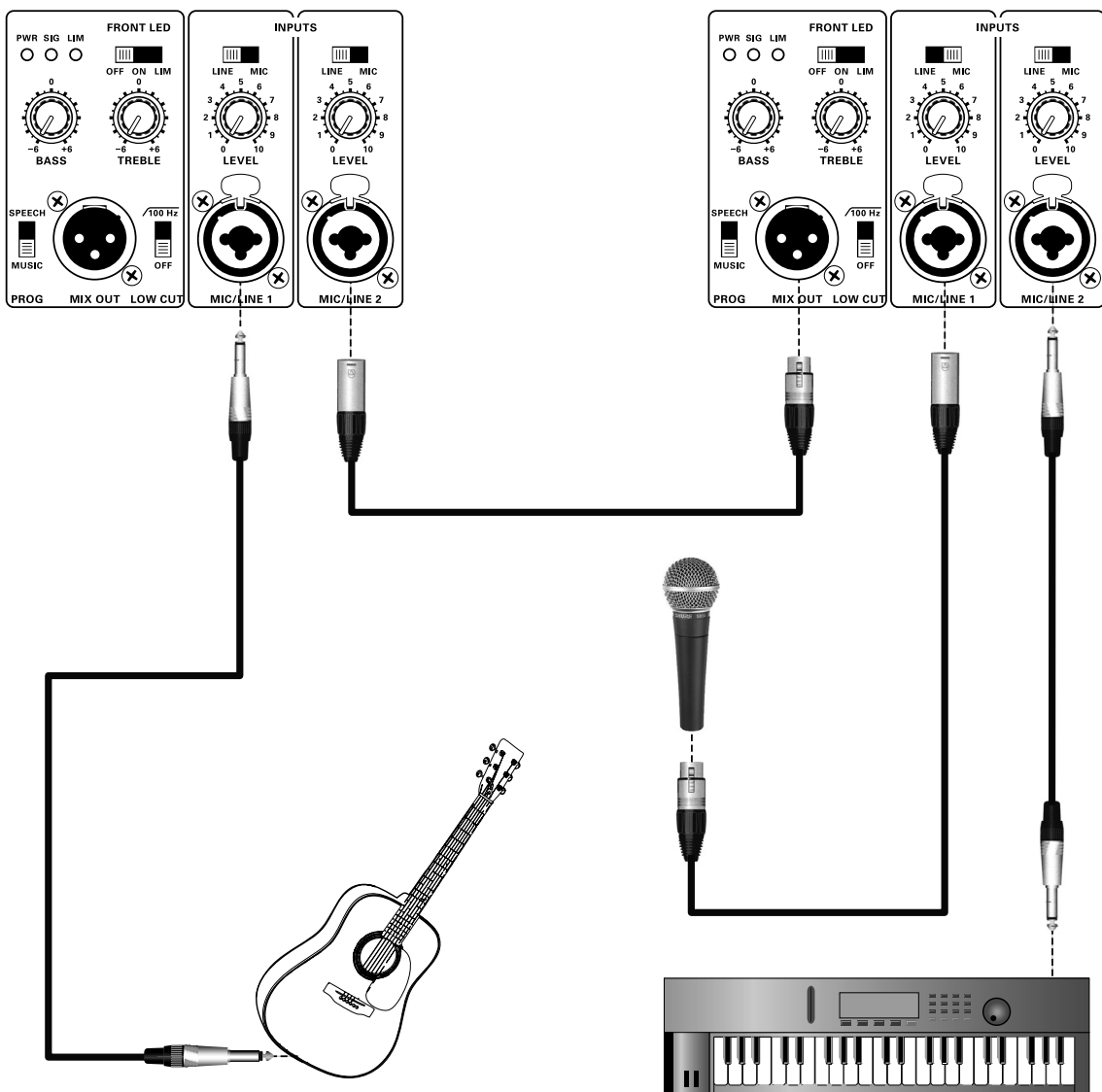

## Stereo PA with an external mixer

Two Milan loudspeakers form the left and right elements of a stereo PA setup with all signal sources connected to an external mixing console. Ensure that the **MIC/LINE** switch is set to **LINE** on both loudspeakers. Set the **LOW CUT** switch to the 'OFF' position when not using subwoofers. For mixed vocal and music program material set the **PROG** switch to 'MUSIC'. Bring up the master faders on the mixer, ensuring that the outputs are not clipping, and then adjust both loudspeakers' level controls to the desired loudness. Adjust the bass and treble controls as required to achieve a suitable frequency response from the system. For consistent balance and response set the level controls and tone controls to approximately the same positions on both cabinets.

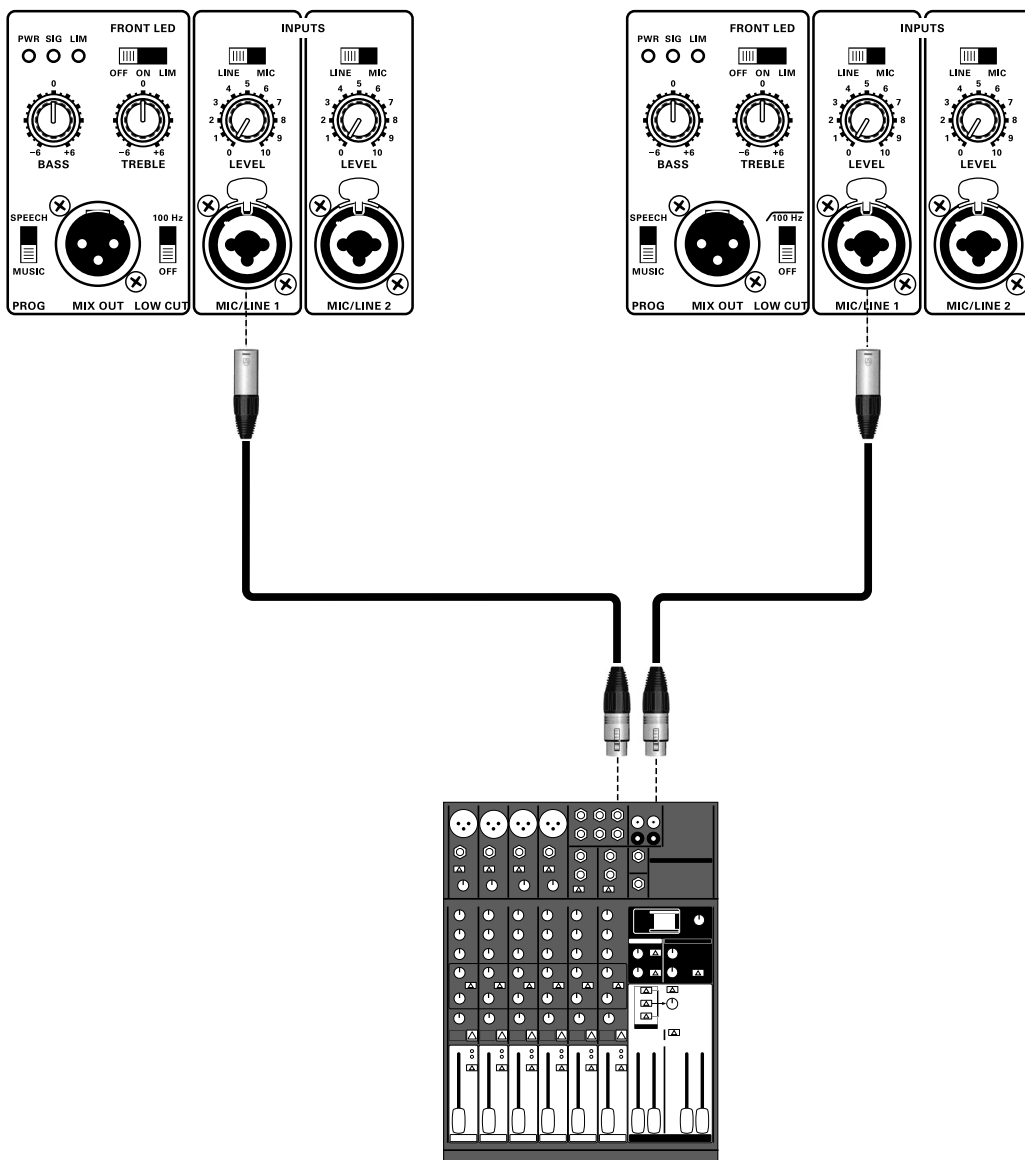

### Stereo PA with an external mixer and subwoofer(s)

In this example, sub frequencies are routed to a separate subwoofer(s) in order to gain extended frequency response and higher overall sound level. Connect the mixer output first to the subwoofers and then loop up to the Milan mid/high loudspeakers. Set the **MIC/LINE** switch to **LINE** and set the **LOW CUT** switch to the 100 Hz position to roll off the low frequencies to the Milan mid/high loudspeakers. The tone controls on both cabinets should be set to the same positions, nominally flat to begin with. Ensure that the mixer outputs are not clipping, and then adjust both loudspeakers' level controls to the desired loudness.

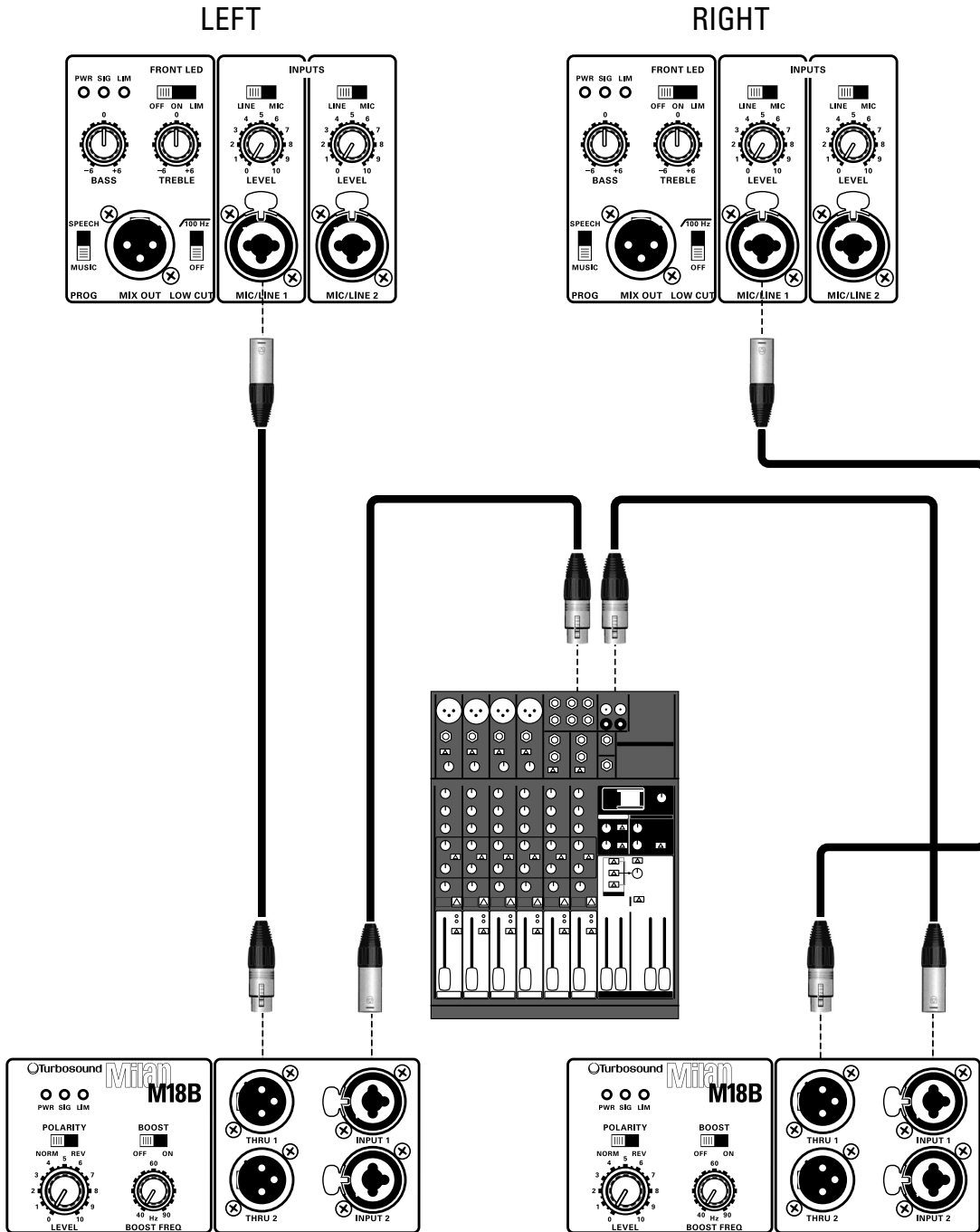

## Stereo PA with powered wedge monitors

On larger gigs a separate monitor system provides good quality foldback for individual performers and helps to keep the front of house PA sound less cluttered. Set the **LOW CUT** switch on the monitor speakers to the 100 Hz position for best results if used on the floor.

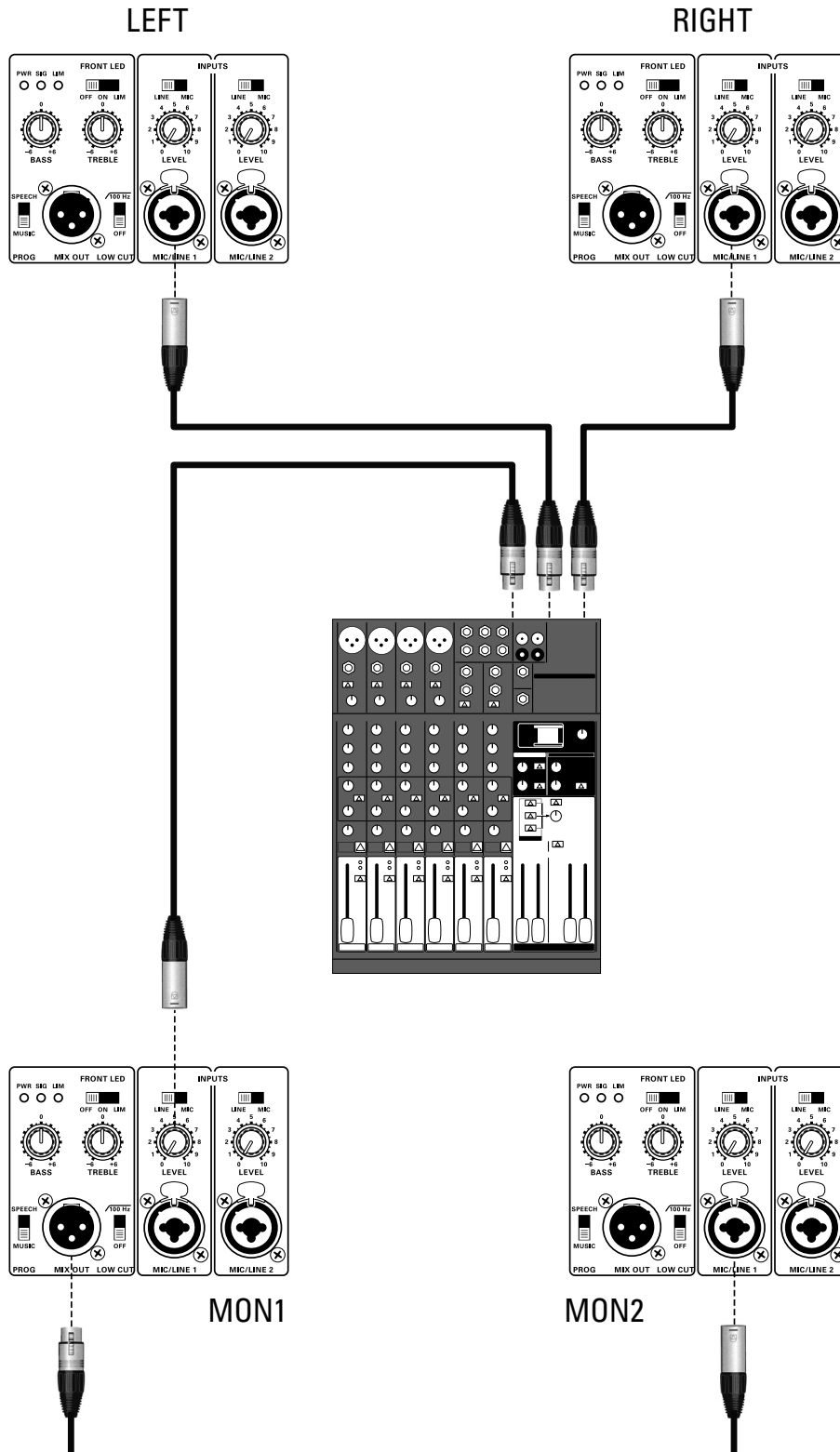

## Connecting to the Milan Loudspeaker

### 1. Mains Connector and Fuseholder

Mains power is connected to the loudspeaker via a combination IEC connector and fuseholder.

### 2. Mains Switch

Rocker switch turns mains power on to the loudspeaker. Make sure the level controls are fully off (MIN) before switching on.

### 3. Signal Input

These combo female XLR/jack connectors accept both XLR connectors and mono (2 pole) or stereo (3 pole) ¼" jack plugs for use with a variety of balanced and unbalanced microphones, instruments and line sources. The inputs are electronically balanced to avoid hum loops and RF interference, and are wired pin 2 hot, pin 3 cold.

#### 100 Hz Low Cut Switch

This low cut filter can be switched in when using the Milan loudspeaker with subwoofers or when used as a floor monitor. It introduces a fourth order low cut filter in the lower part of the frequency response at 100 Hz, and is useful to avoid boominess due to proximity to the floor when the loudspeaker is used as a floor monitor. The low cut should also be selected when used with sub-bass loudspeakers and allows bass frequencies to be routed appropriately to the sub-bass speakers, avoiding an overlap, and giving greater clarity and definition to the overall sound.

### 4. Mix Out

A balanced line level signal output on a balanced male XLR connector that connects to additional powered Milan loudspeakers. This output contains a mix of all connected sources and is post-EQ, although it is independent of the 100 Hz low cut switch. Note that adjusting equalisation will similarly affect any additional Milan loudspeakers connected to this output.

### 5. Program Switch

Sets a frequency response contour optimised for either voices or mixed music program material.

### 6. Treble Control

The treble control provides  $\pm 6$  dB of shelving at 12 kHz. Always use equalisation sparingly, aiming to cut rather than boost especially when the loudspeaker is used near boundaries such as walls or floors.

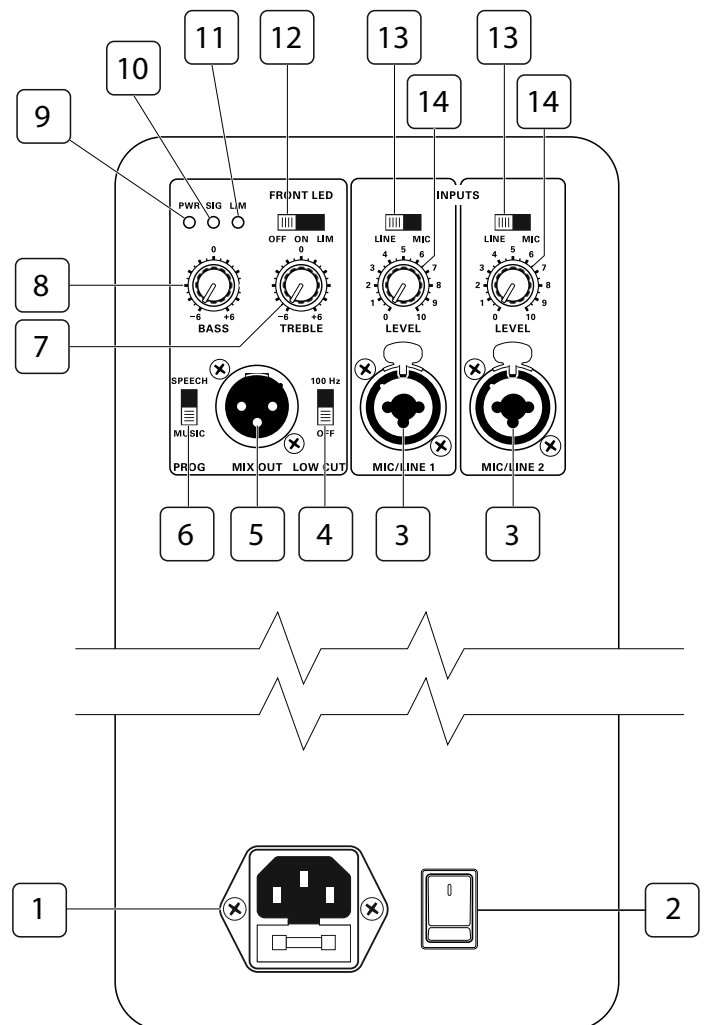



**7. Bass Control**

The bass control provides  $\pm 6$  dB of shelving at 80 Hz. Always use equalisation sparingly, aiming to cut rather than boost especially when the loudspeaker is used near boundaries such as walls or floors.

**8. Power On Indicator**

Blue LED illuminates when mains power is applied to the loudspeaker and powered up via the rocker switch.

**9. Signal Indicator**

Illuminates green when the signal level reaches -6 dB, and is a useful indicator of the input signal approaching the limiter threshold.

**10. Limit Indicator**

Illuminates red when the signal level approaches maximum and the limiters start working. Frequent and/or continuous lighting of limit LED indicates overdriving. If this occurs reduce the input level to the loudspeaker or enlarge your system with additional loudspeakers.

**11. Front LED Status**

The function of the illuminated front badge can be toggled between permanently on, permanently off, or to indicate action of the limiting circuits.

**12. Mic / Line Switch**

Selects the input for that channel to accept either a low level, low impedance microphone, or a high level, high impedance source such as a mixing console, keyboard or acoustic instrument with onboard electrics. The mic input is not suitable for condenser microphones that require phantom power.

**13. Level Control**

Rotary level control which attenuates the input signal level of the connected instrument / line source for that input channel. The range (mic) is from  $-\infty$  (MIN) to +68 dB (MAX) and (line) from  $-\infty$  (MIN) to +38 dB (MAX).

## Connecting to the Milan Subwoofer

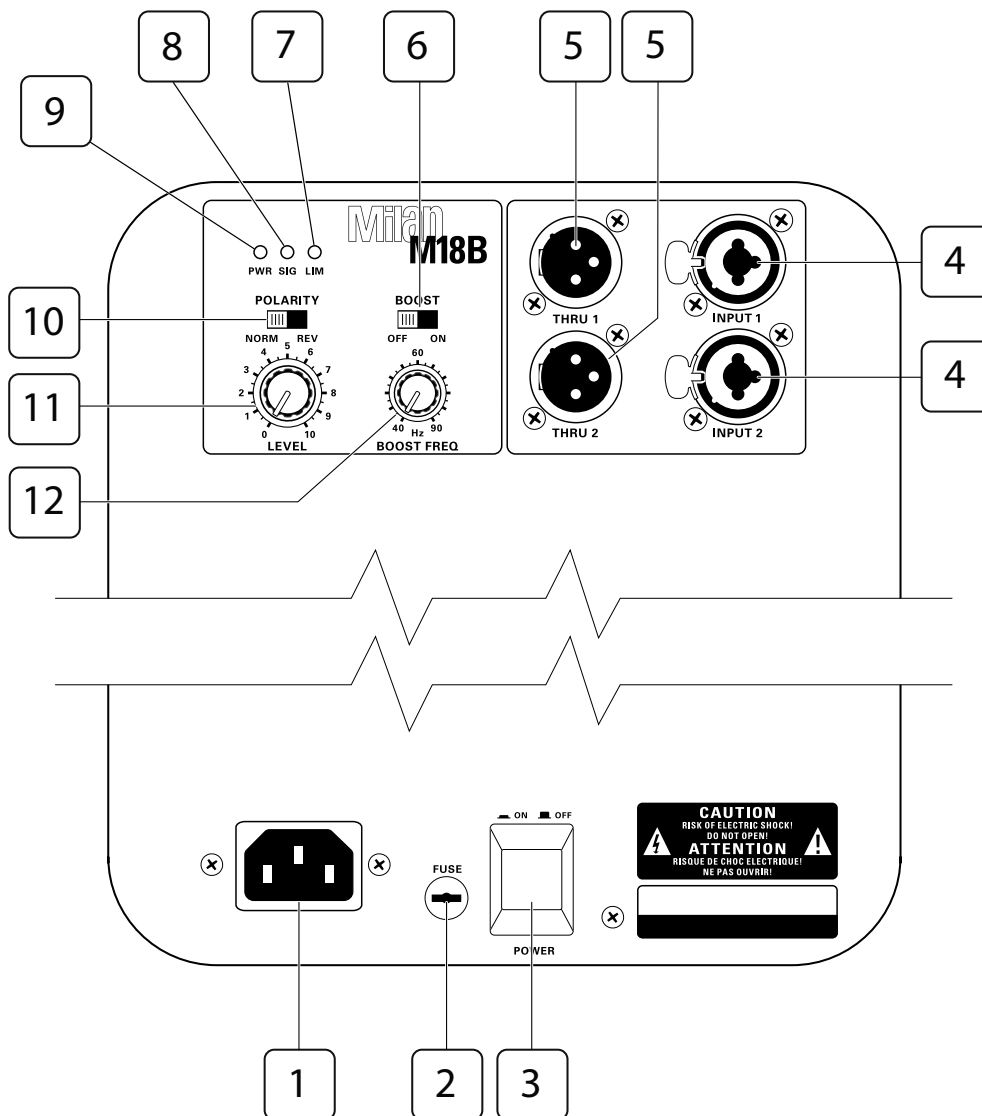

### 1. Mains Connector

Mains power is connected to the subwoofer via an IEC connector.

### 2. Fuseholder

Replace fuse only with the same type and rating.

### 3. Mains Switch

Toggle push switch turns mains power on to the loudspeaker. Make sure the level control is fully off (MIN) before switching on.

### 4. Inputs

These combo female XLR/jack connectors accept both 3-pin XLR connectors and mono (2 pole) or stereo (3 pole) ¼" jack plugs for connection to balanced or unbalanced mixing console outputs. The inputs are electronically balanced to avoid hum loops and RF interference, and are wired pin 2 hot, pin 3 cold.

**5. Thru Connections**

These 3-pin balanced male XLR connectors provide independent full range audio signals from each input channel for loop-through connections to Milan two-way loudspeakers or additional Milan subwoofers.

**6. Boost**

Applies +3 dB of boost with a Q factor of 1 at a centre frequency selected via the associated boost freq control (12).

**7. Limit Indicator**

Illuminates red when the signal level approaches maximum and the limiters start working. Frequent and/or continuous lighting of limit LED indicates overdriving. If this occurs reduce the input level to the loudspeaker or enlarge your system with additional loudspeakers.

**8. Signal Indicator**

Illuminates green when the signal level reaches -6 dB, and is a useful indicator of the input signal approaching the limiter threshold.

**9. Power On Indicator**

Blue LED illuminates when mains power is applied to the subwoofer and powered up via the rocker switch.

**10. Polarity**

Reverses the polarity of the subwoofer relative to the two-way Milan loudspeakers connected to the thru outputs.

**11. Level Control**

Rotary level control which attenuates the input signal level of the subwoofer and (line) from  $-\infty$  (MIN) to +43 dB (MAX).

**12. Boost Freq**

Selects the centre frequency at which the boost is applied, and is continuously variable from 40 Hz to 90 Hz.

## Getting Started – Milan M10, M12 and M15

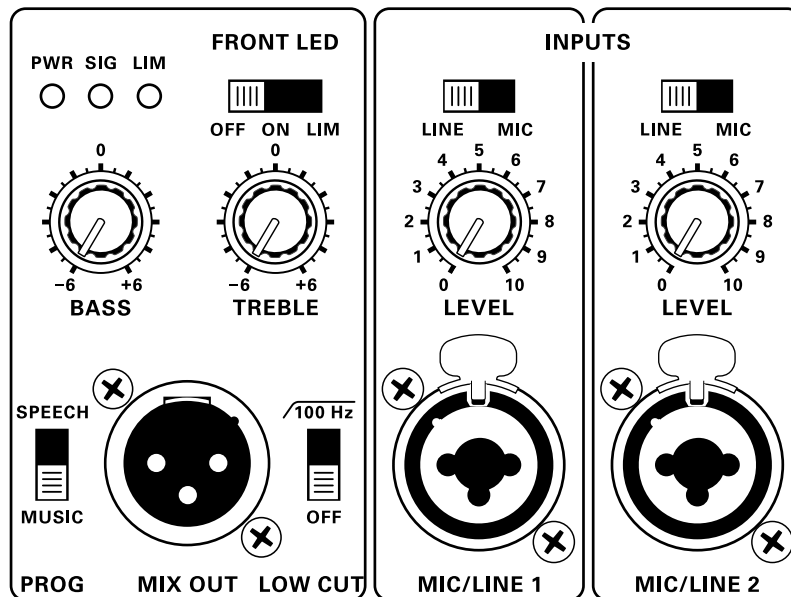

1. Turn the level controls fully anticlockwise (zero) on both input channels.
2. Set the **BASS** and **TREBLE** tone controls to their centre position (no boost or cut).
3. Connect your signal sources (mixing console, keyboard, microphone, acoustic guitar) to the appropriate input connectors and select **MIC** or **LINE** as appropriate for that source.
4. If the loudspeaker is to be used as a floor monitor, or for use with subwoofers, set the **LOW CUT** switch to the '**100 HZ**' position (up); otherwise select the '**OFF**' position (down).
5. Switch on the mixer or other source and make sure the output faders or master output level controls are turned fully down.
6. Connect the AC mains cable to the Milan loudspeaker and turn on the mains switch. The blue **PWR** LED will illuminate to indicate that mains power is connected.
7. Increase the output level of the signal source to a normal operating level.
8. Slowly turn up the Milan loudspeaker's level control(s) until a suitable volume level is reached. The **SIG** LED illuminates green to indicate signal present. The **LIM** LED flashes red when the system limiting although it is normal for the **LIM** LED to flash occasionally. Excessive or prolonged illumination indicates that the input signal is too high or that additional speakers are required.
9. When shutting down the Milan system, first turn down the input level controls, then switch off the mains power before turning off the mixer or signal source.

## Getting Started – Milan M15B and M18B Subwoofers

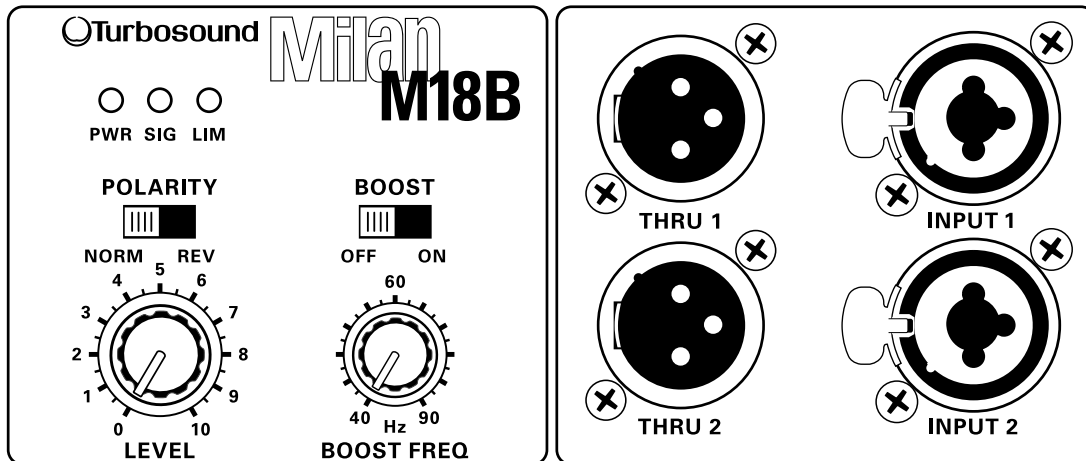

1. Turn the **LEVEL** control fully anticlockwise (zero).
2. Connect the left and right outputs from your mixing console to the appropriate input connectors.
3. Switch on the mixing console and make sure the output faders or master output level controls are turned fully down.
4. Connect the AC mains cable to the Milan subwoofer and turn on the mains switch. The blue **PWR** LED will illuminate to indicate that mains power is connected.
5. Increase the output level of the signal source to a normal operating level.
6. Slowly turn up the Milan subwoofer's **LEVEL** control until a suitable volume level and balance with the Milan mid/high loudspeaker is reached. The **SIG** LED illuminates green to indicate signal present. The **LIM** LED flashes red when the system limiting although it is normal for the **LIM** LED to flash occasionally. Excessive or prolonged illumination indicates that the input signal is too high or that additional speakers are required.
7. In the majority of cases where the Milan mid/high loudspeakers are physically in line with the subwoofers, for example when used on a straight speaker pole above the subwoofer, the **POLARITY** switch should be set to **NORM** for optimum results. However when the Milan mid/high loudspeakers are either in front of, or behind, the subwoofers you should experiment with the **POLARITY** switch and choose whichever position gives the best subjective integration with the subwoofer.
8. If additional bass response is required the **BOOST** switch provides +3 dB of lift centred at the frequency selected using the **BOOST FREQ** control.
9. When shutting down the Milan system, first turn down the input level controls, then switch off the mains power before turning off the mixer or signal source.

## Using Milan Loudspeakers with Subwoofers

Improved bass response and higher overall sound pressure level can be achieved by adding sub-bass loudspeakers to the Milan system. This also reduces mechanical stress on the Milan loudspeaker's low frequency driver, since most of the low frequency content in the signal is routed to the subwoofer.

It is recommended that you connect the full range signal from the mixer first to the subwoofer(s), and then link from the subwoofer(s) to the Milan loudspeaker.

When using Milan with subwoofers, best results will be obtained by filtering the frequency response of the individual cabinets in order to avoid an overlap in the combined response. Move the **LOW CUT** switch to the **100 HZ** position (up).



**LOW CUT**

## Using Milan as a Floor Monitor

When using the Milan loudspeaker as a floor monitor it is recommended that you activate the **LOW CUT** switch to avoid any low frequency boominess that can occur due to the proximity of the floor, which can detract from clear and intelligible monitor sound, particularly vocals.



**LOW CUT**



In order to further improve vocal intelligibility in floor monitors you can also reduce the level of the **BASS CONTROL** as required.

If you are using Milan as part of a larger multi-channel monitor system and where drums may be part of the monitor mix it is recommended that kick drum EQ is used sparingly and carefully, aiming to cut rather boost at bass frequencies.

# Connector Wiring

The microphone and line inputs are designed to accept balanced (three conductor) connections, and it is recommended that this method be used since it offers the best rejection of noise, hum and radio interference, especially where long cable runs are involved. XLR connectors should be wired pin 2 hot (positive), pin 3 cold (negative) and pin 1 ground, while the standard wiring for 3-pole jack plug connectors is tip hot (positive), ring cold (negative) and sleeve ground as shown below.

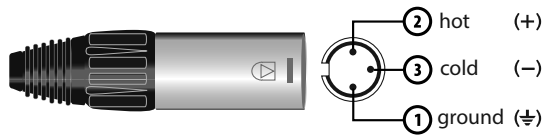

Balanced male XLR

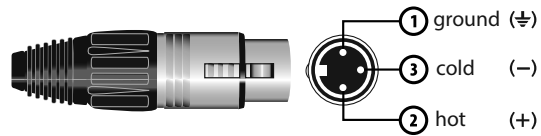

Balanced female XLR

Some signal sources such as keyboards and acoustic guitars with on-board electronics commonly provide only an unbalanced output on a 2-pole jack connector. The Milan loudspeaker line input can handle these connections without any rewiring since pin 3 (-ve) of the input is automatically grounded by the jack plug.

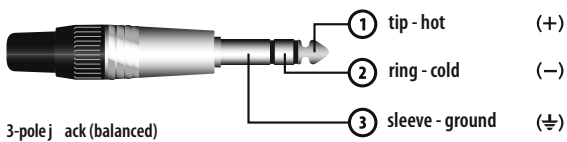

3-pole jack (balanced)

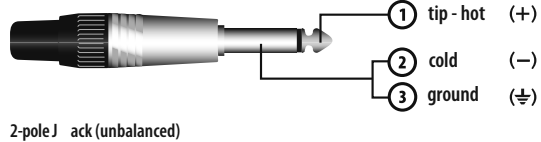

2-pole jack (unbalanced)

If an unbalanced source is to be connected to an input channel via the XLR line input connector, either 2-pole or 3-pole jack plugs can be used. In both cases pin 3 should be connected to pin 1 (ground) at the XLR as shown here.

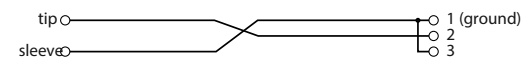
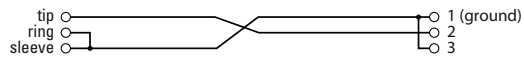
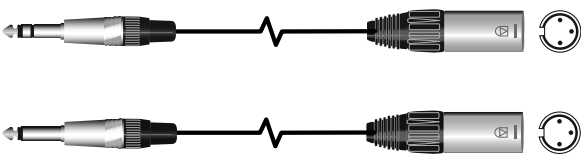

Some sources such as mp3 players or CD players commonly provide 2-pole unbalanced phono connectors, and these can be connected to a line input via either the XLR connector or jack connector. In either case wire the connectors as follows:

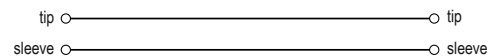
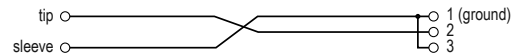
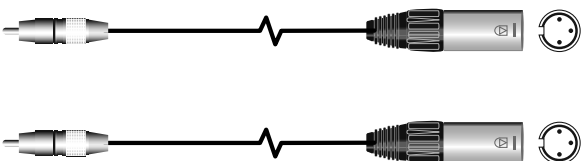

## Loudspeaker Placement

In order to avoid the possibility of feedback, always locate the loudspeakers in front of your microphones and do not point microphones directly at the front of a loudspeaker.

When using speaker stands, try to raise the loudspeakers as high as practically possible (at least higher than the heads of the audience) since people are very good absorbers of sound, especially at high frequencies. You also have the option to point them down using the alternate angle provided for by the built-in dual-angle pole holder. Doing this will improve the coverage for both near and far audience members.

**SAFETY PRECAUTIONS:** make sure that any speaker stands you use are capable of taking the weight of the loudspeaker, and that stands are placed on a flat, level and stable surface. Make sure that the legs do not present a trip hazard. Be careful when lifting the speaker on to the stand; check the weight first before lifting and ask someone else to help you if needed.

The same applies to using Milan loudspeakers mounted on straight poles on top of bass cabinets or subwoofers. Adjustable height poles or stands allow you to fine tune the height of the loudspeakers to suit your venue.

Do not place your loudspeakers too close to turntables as this may induce rumble or low frequency feedback from the tone arms. Isolate turntables on shock mounts.

Use equalisation sparingly. Start with the bass and treble controls at their neutral position (no boost or cut). Cut a little bass to tame any boomy frequencies in the room, and add a little treble to help vocal intelligibility.

Consider adding subwoofers and/or further loudspeakers if the overall sound level or low frequency response is not enough for the room.

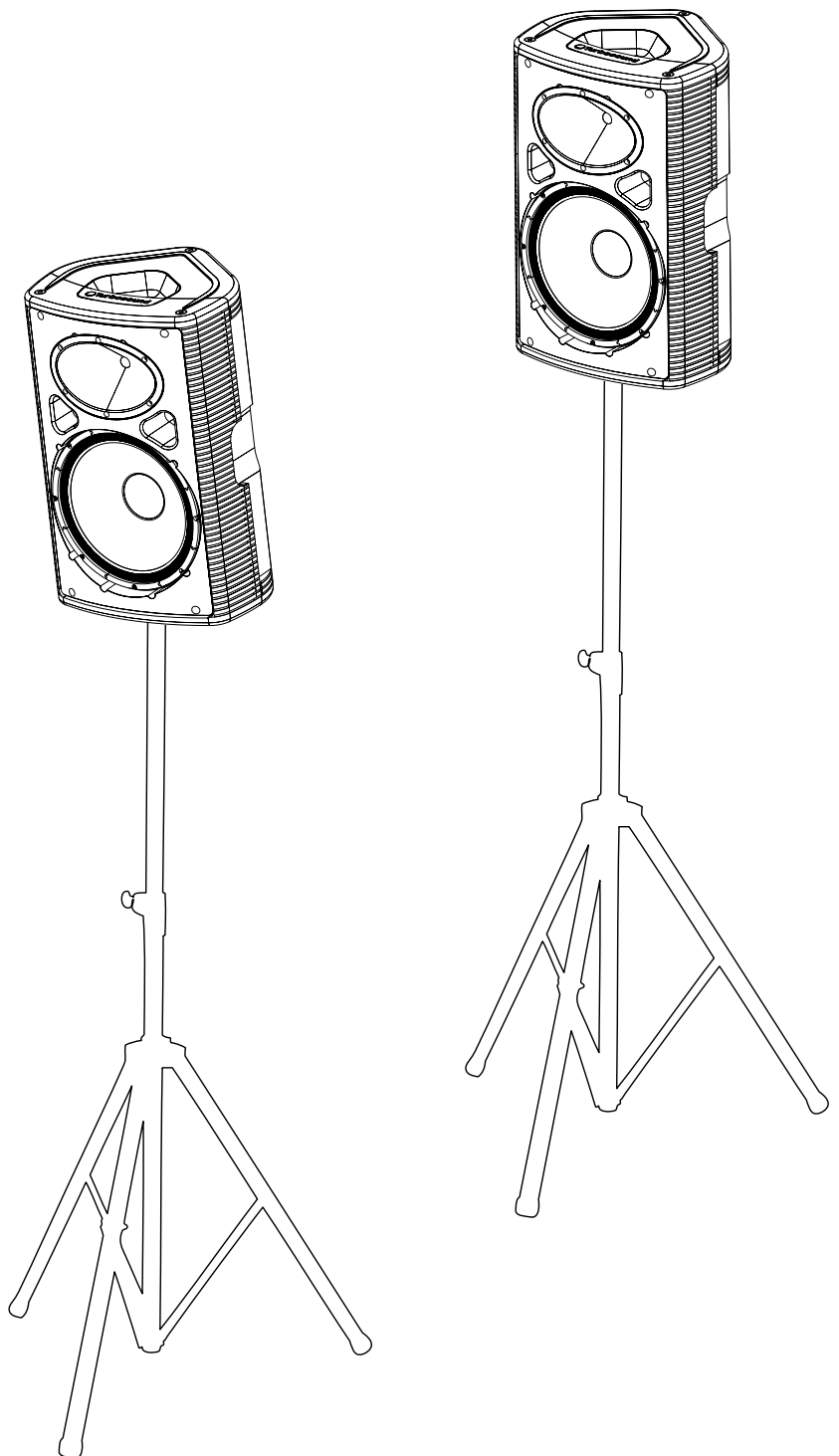



## Installing Milan Loudspeakers

### Using the M10 rigging points

Milan loudspeakers can be permanently installed in a venue, suspended from eyebolts fitted to the internal M10 rigging points on the top and bottom of the cabinet. Three possible orientations are available: vertically upright, or upside down to position the high frequency driver closer to the audience, or sideways if required.

Insert M10 load-rated shoulder eyebolts into the threaded rigging points and tighten. The front rigging points should take the majority of the load while the rear rigging point should be used for angling the cabinet downwards only.

When installing the cabinet sideways, pick up from either of the two front eyebolt pairs, and bridle the two rear eyebolt points to provide a single pull-back for adjusting the downward angle.

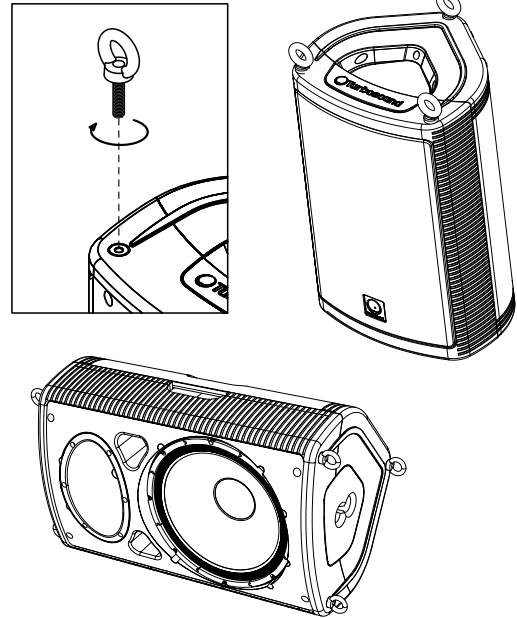

### Wall Mounting

The Milan loudspeaker can be conveniently wall mounted using the PB-55 pole mount wall bracket, which simply locates into the pole mount socket in the bottom of the cabinet.

Mount the bracket to the wall using suitable fixings, and locate the loudspeaker onto the pole mount bracket. Rotate and angle the loudspeaker to optimise coverage and tighten the locking mechanism to stop the loudspeaker from being inadvertently removed.

## INSTRUCTIONS FOR QUALIFIED PERSONNEL ONLY

### FASTENING OF BRACKET ASSEMBLY

The operation of your speaker cabinet as part of a flown system, if installed incorrectly and improperly, can potentially expose persons to serious health risks and even death. In addition, please ensure that electrical, mechanical and acoustic considerations are discussed with qualified and certified (by local state or national authorities) personnel prior to any installation or flying.

Make sure that speaker cabinets are set up and “flown” by qualified and certified personnel only, using dedicated equipment and original parts and components delivered with the unit. If any parts or components are missing please contact your Dealer before attempting to set up the system.

Be sure to observe the local, state and other safety regulations applicable in your country. MUSIC Group, including the MUSIC Group companies listed on the enclosed “Service Information Sheet”, assume no liability for any damage or personal injury resulting from improper use, installation or operation of the product. Regular checks must be conducted by qualified personnel to ensure that the system remains in a secure and stable condition. Make sure that, where the speaker is flown, the area underneath the speaker is free of human traffic. Do not fly the speaker in areas which can be entered or used by members of the public.

Speakers create a magnetic field, even if not in operation. Therefore, please keep all materials which can be affected by such fields (discs, computers, monitors etc) at a safe distance. A safe distance is usually between 1 and 2 metres.

## Troubleshooting

Fault	Check	Action
No power to the loudspeaker	Is the mains lead plugged in?	Connect the mains lead
	Is the mains outlet live?	Check the mains outlet or switch to another outlet
	Is the power switch on?	Press the mains switch
No sound / quiet sound	Are the level controls turned down (anti-clockwise)?	Turn the control slowly clockwise
	Is the source sending a signal?	Verify signal at the source output. Un-mute muted outputs or mixer channels. Check cables and replace
No sound from connected microphone	Is the microphone a condenser type needing phantom power?	Milan does not supply +48v phantom power. Use a dynamic microphone or connect to a mixer with phantom power
No sound although loudspeaker is on	Is the loudspeaker in protect mode?	Turn off the mains switch, unplug the loudspeaker before reconnecting
	Does the loudspeaker remain in protect mode?	Refer to qualified service personnel
Distorted sound	Is the input signal level too high?	Reduce mixer, preamp or source level
	Is the mic/line switch set incorrectly	Change mic/line setting to correct source
Distorted sound, limit LED is on continuously	Are the level controls set too high?	Reduce volume controls or use additional loudspeakers
Exaggerated bass response when used as floor monitor	Is the Low Cut filter switched out?	Switch the Low Cut filter to 'on' and/or reduce the bass control
Hum or noise	Are the connected sources balanced?	Use balanced cables and 3-pole connectors wherever possible. Check wiring
	Ground loops?	Lift audio ground on affected device with adapter
	Are signal cables near or running parallel to mains cables?	Move signal cables

# Technical Specifications

Model	M10	M12	M15	M15B	M18B
Components	1 x 10" LF driver 1 x 1" HF driver	1 x 12" LF driver 1 x 1" HF driver	1 x 15" LF driver 1 x 1" HF driver	1 x 15" LF driver	1 x 18" LF driver
Connectors	Mic/Line input: combo jack/female XLR wired pin 2 hot; Mix out: male XLR wired pin 2 hot; IEC mains connector with integrated fuseholder			Input: 2 x female XLR wired pin 2 hot; Thru: 2 x male XLR wired pin 2 hot; IEC mains connector with integrated fuseholder	
<b>Controls</b>					
Controls	Level, Line/Mic, Low Cut, Speech/Music, Bass and Treble, Front LED, Mains on/off			Level, Polarity, Boost, Boost Frequency	
<b>System Data</b>					
Frequency Range	55 Hz–18 kHz ±3 dB 50 Hz–20 kHz -10 dB	50 Hz–18 kHz ±3 dB 45 Hz–20 kHz -10 dB	45 Hz–18 kHz ±3 dB 40 Hz–20 kHz -10 dB	45 Hz–100 Hz ±3 dB 35 Hz–150 Hz -10 dB	40 Hz–100 Hz ±3 dB 30 Hz–150 Hz -10 dB
Dispersion @-6 dB pts	90° H x 60° V	90° H x 60° V	90° H x 60° V	N/A	N/A
Max SPL (continuous)	119.5 dB	121 dB	123 dB	127.5 dB (half space)	127.5 dB (half space)
Equalisation	Bass: ±6 dB @ 80 Hz; Treble: ±6 dB @ 12 kHz			N/A	
Boost Frequency	N/A			+3 dB @ 40 Hz–90 Hz, Q=1	
<b>Indicators</b>					
Power LED	Blue			Blue	
Signal LED	Green			Green	
Limit LED	Red			Red	
Clip LED	Red			N/A	
<b>Circuit Protection</b>					
Amplifier Protection	Full short circuit, open circuit, thermal			Full short circuit, thermal, overcurrent, DC	
<b>LF/HF Driver</b>					
Max Output Power	LF: 500 W HF: 100 W	LF: 1000 W HF: 100 W		2200 W	
<b>Audio Inputs</b>					
Input Sensitivity	Mic: -32 dBu; Line: -2 dBu			+4 dBu @ centre position for full rated power	
Input Impedance	Mic: 560 Ω unbalanced, 1 kΩ balanced; Line: 20 kΩ unbalanced, 40 kΩ balanced			10 kΩ unbalanced, 20 kΩ balanced	
<b>Power Supply, Voltage (Fuses)</b>					
USA / Canada	100–120 V~, T 6.3 A H 250 V	100–120 V~, T 8.0 A H 250 V		100–120 V~, T 12 A H 250 V	
UK / Australia / Europe	220–240 V~, T 3.15 A H 250 V	220–240 V~, T 4.0 A H 250 V		220–240 V~, T 6.3 A H 250 V	
China	220–240 V~, T 3.15 A H 250 V	220–240 V~, T 4.0 A H 250 V		220–240 V~, T 6.3 A H 250 V	
Japan	100–120 V~, T 6.3 A H 250 V	100–120 V~, T 8.0 A H 250 V		100–120 V~, T 12 A H 250 V	
Power consumption @ 1/8 max power	80 W	140 W		280 W	
Rigging options	6 x M10 threaded internal rigging points			N/A	
<b>Construction / Dimensions / Weight</b>					
Construction	Injection-moulded polypropylene enclosure. Recessed carrying handles. Integral dual-angle pole mount socket. Powder coated galvanised perforated steel mesh grille with foam backing			Birch plywood, screwed and glued	
Dimensions (H x W x D)	522 x 329 x 294 mm (20.6 x 13 x 11.6")	620 x 394 x 330 mm (24.4 x 15.5 x 13")	719 x 457 x 368 mm (28.3 x 18 x 14.5")	495 x 530 x 480 mm (19.5 x 20.9 x 18.9")	590 x 640 x 530 mm (23.2 x 25.2 x 20.9")
Net weight	13.3 kg (29.3 lbs)	20.5 kg (45.1 lbs)	27.7 kg (60.9 lbs)	37 kg (81.4 lbs)	48 kg (105.6 lbs)

## Spare Parts and Accessories

Model	Description
LS-1032	10" (254 mm) low frequency driver for M10
LS-1229	12" (305 mm) low frequency driver for M12
LS-1534	15" (381 mm) low frequency driver for M15
LS-1535	15" (381 mm) low frequency driver for M15B
LS-1819	18" (457 mm) low frequency driver for M18B
RC-1032	Recone kit for M10
RC-1229	Recone kit for M12
RC-1534	Recone kit for M15
RC-1535	Recone kit for M15B
RC-1819	Recone kit for M18B
CD-125	HF compression driver for M10, M12 and M15
RD-125	HF diaphragm for M10, M12 and M15
AMP-M10	Replacement amplifier assembly for M10
AMP-M12M15	Replacement amplifier assembly for M12 and M15
AMP-M15BM18B	Replacement amplifier assembly for M15B and M18B
PA-60	Speaker pole 35 mm x 60 cm long
PA-90	Speaker pole 35mm x 90cm long
PA-100	Speaker pole 35mm x 100cm long
PA-120	Speaker pole 35mm x 120cm long
PB-55	Pole mount wall bracket
EB-10	M10 shoulder eyebolt

# Other important information

## EN Important information

**1. Register online.** Please register your new MUSIC Group equipment right after you purchase it by visiting [turbosound.com](http://turbosound.com). Registering your purchase using our simple online form helps us to process your repair claims more quickly and efficiently. Also, read the terms and conditions of our warranty, if applicable.

**2. Malfunction.** Should your MUSIC Group Authorized Reseller not be located in your vicinity, you may contact the MUSIC Group Authorized Fulfiller for your country listed under "Support" at [turbosound.com](http://turbosound.com). Should your country not be listed, please check if your problem can be dealt with by our "Online Support" which may also be found under "Support" at [turbosound.com](http://turbosound.com). Alternatively, please submit an online warranty claim at [turbosound.com](http://turbosound.com) BEFORE returning the product.

**3. Power Connections.** Before plugging the unit into a power socket, please make sure you are using the correct mains voltage for your particular model. Faulty fuses must be replaced with fuses of the same type and rating without exception.

## ES Aspectos importantes

**1. Registro online.** Le recomendamos que registre su nuevo aparato MUSIC Group justo después de su compra accediendo a la página web [turbosound.com](http://turbosound.com). El registro de su compra a través de nuestro sencillo sistema online nos ayudará a resolver cualquier incidencia que se presente a la mayor brevedad posible. Además, aproveche para leer los términos y condiciones de nuestra garantía, si es aplicable en su caso.

**2. Averías.** En el caso de que no exista un distribuidor MUSIC Group en las inmediaciones, puede ponerse en contacto con el distribuidor MUSIC Group de su país, que encontrará dentro del apartado "Support" de nuestra página web [turbosound.com](http://turbosound.com). En caso de que su país no aparezca en ese listado, acceda a la sección "Online Support" (que también encontrará dentro del apartado "Support" de nuestra página web) y compruebe si su problema aparece descrito y solucionado allí. De forma alternativa,

envíenos a través de la página web una solicitud online de soporte en periodo de garantía ANTES de devolvernos el aparato.

### 3. Conexiones de corriente.

Antes de enchufar este aparato a una salida de corriente, asegúrese de que dicha salida sea del voltaje adecuado para su modelo concreto. En caso de que deba sustituir un fusible quemado, deberá hacerlo por otro de idénticas especificaciones, sin excepción.

## FR Informations importantes

**1. Enregistrez-vous en ligne.** Prenez le temps d'enregistrer votre produit MUSIC Group aussi vite que possible sur le site Internet [turbosound.com](http://turbosound.com). Le fait d'enregistrer le produit en ligne nous permet de gérer les réparations plus rapidement et plus efficacement. Prenez également le temps de lire les termes et conditions de notre garantie.

**2. Dysfonctionnement.** Si vous n'avez pas de revendeur MUSIC Group près de chez vous, contactez le distributeur MUSIC Group de votre pays : consultez la liste des distributeurs de votre pays dans la page "Support" de notre site Internet [turbosound.com](http://turbosound.com). Si votre pays n'est pas dans la liste, essayez de résoudre votre problème avec notre "aide en ligne" que vous trouverez également dans la section "Support" du site [turbosound.com](http://turbosound.com). Vous pouvez également nous faire parvenir directement votre demande de réparation sous garantie par Internet sur le site [turbosound.com](http://turbosound.com) AVANT de nous renvoyer le produit.

**3. Raccordement au secteur.** Avant de relier cet équipement au secteur, assurez-vous que la tension secteur de votre région soit compatible avec l'appareil. Veillez à remplacer les fusibles uniquement par des modèles exactement de même taille et de même valeur électrique — sans aucune exception.

## DE Weitere wichtige Informationen

**1. Online registrieren.** Bitte registrieren Sie Ihr neues MUSIC Group-Gerät direkt nach dem Kauf auf der Website [turbosound.com](http://turbosound.com). Wenn Sie Ihren Kauf mit unserem einfachen online Formular registrieren, können wir Ihre Reparaturansprüche schneller und effizienter bearbeiten. Lesen Sie bitte auch unsere Garantiebedingungen, falls zutreffend.

**2. Funktionsfehler.** Sollte sich kein MUSIC Group Händler in Ihrer Nähe befinden, können Sie den MUSIC Group Vertrieb Ihres Landes kontaktieren, der auf [turbosound.com](http://turbosound.com) unter „Support“ aufgeführt ist. Sollte Ihr Land nicht aufgelistet sein, prüfen Sie bitte, ob Ihr Problem von unserem „Online Support“ gelöst werden kann, den Sie ebenfalls auf [turbosound.com](http://turbosound.com) unter „Support“ finden. Alternativ reichen Sie bitte Ihren Garantieanspruch online auf [turbosound.com](http://turbosound.com) ein, BEVOR Sie das Produkt zurücksenden.

**3. Stromanschluss.** Bevor Sie das Gerät an eine Netzsteckdose anschließen, prüfen Sie bitte, ob Sie die korrekte Netzspannung für Ihr spezielles Modell verwenden. Fehlerhafte Sicherungen müssen ausnahmslos durch Sicherungen des gleichen Typs und Nennwerts ersetzt werden.

## PT Outras Informações Importantes

**1. Registre-se online.** Por favor, registre seu novo equipamento MUSIC Group logo após a compra visitando o site [turbosound.com](http://turbosound.com) Registrar sua compra usando nosso simples formulário online nos ajuda a processar seus pedidos de reparos com maior rapidez e eficiência. Além disso, leia nossos termos e condições de garantia, caso seja necessário.

**2. Funcionamento Defeituoso.** Caso seu fornecedor MUSIC Group não esteja localizado nas proximidades, você pode contatar um distribuidor MUSIC Group para o seu país listado abaixo de "Suporte" em [turbosound.com](http://turbosound.com). Se seu país não estiver na lista, favor checar se seu problema pode ser resolvido com o nosso "Suporte Online" que também pode ser achado abaixo de "Suporte" em [turbosound.com](http://turbosound.com). Alternativamente, favor enviar uma solicitação de garantia online em [turbosound.com](http://turbosound.com) ANTES da devolução do produto.

**3. Ligações.** Antes de ligar a unidade à tomada, assegure-se de que está a utilizar a voltagem correcta para o modelo em questão. Os fusíveis com defeito terão de ser substituídos, sem qualquer excepção, por fusíveis do mesmo tipo e corrente nominal.

# FEDERAL COMMUNICATIONS COMMISSION COMPLIANCE INFORMATION



Responsible Party Name: **MUSIC Group Services US Inc.**  
Address: **18912 North Creek Parkway,  
Suite 200 Bothell, WA 98011, USA**  
Phone Number: **+1 425 672 0816**

## **MILAN M18B/M15B/M15/M12/M10**

complies with the FCC rules as mentioned in the following paragraph:

This equipment has been tested and found to comply with the limits for a Class B digital device, pursuant to part 15 of the FCC Rules. These limits are designed to provide reasonable protection against harmful interference in a residential installation. This equipment generates, uses and can radiate radio frequency energy and, if not installed and used in accordance with the instructions, may cause harmful interference to radio communications. However, there is no guarantee that interference will not occur in a particular installation. If this equipment does cause harmful interference to radio or television reception, which can be determined by turning the equipment off and on, the user is encouraged to try to correct the interference by one or more of the following measures:

- Reorient or relocate the receiving antenna
- Increase the separation between the equipment and receiver
- Connect the equipment into an outlet on a circuit different from that to which the receiver is connected
- Consult the dealer or an experienced radio/TV technician for help

This device complies with Part 15 of the FCC rules. Operation is subject to the following two conditions:

- (1) this device may not cause harmful interference, and
- (2) this device must accept any interference received, including interference that may cause undesired operation.

### **Important information:**

Changes or modifications to the equipment not expressly approved by MUSIC Group can void the user's authority to use the equipment.



